

X LEGEND^{NX}

LGNXT05CVTF

5.1 CHROMAVIEW HDTV I UNIVERSAL FIXED LENS TURRET CAMERA

- 5MP High-Resolution Imaging
- Chromaview 24/7 night time color
- 2.8mm fixed lens
- Up to 20m for white light distance
- DWDR and 2D DNR for better image clarity
- Supports: TVI, AHD, CVI, CVBS
- Water and dust resistant (IP67)
- Built-in microphone, audio over coaxial cable



In short

This 5MP camera offers high-resolution imaging with 24/7 color images, featuring a 2.8mm fixed lens and up to 20m white light distance. Equipped with DWDR and 2D DNR for enhanced image clarity, it supports multiple video formats (TVI, AHD, CVI, CVBS), has IP67-rated water and dust resistance, and includes a built-in microphone for audio over coaxial cable.

Dimensions

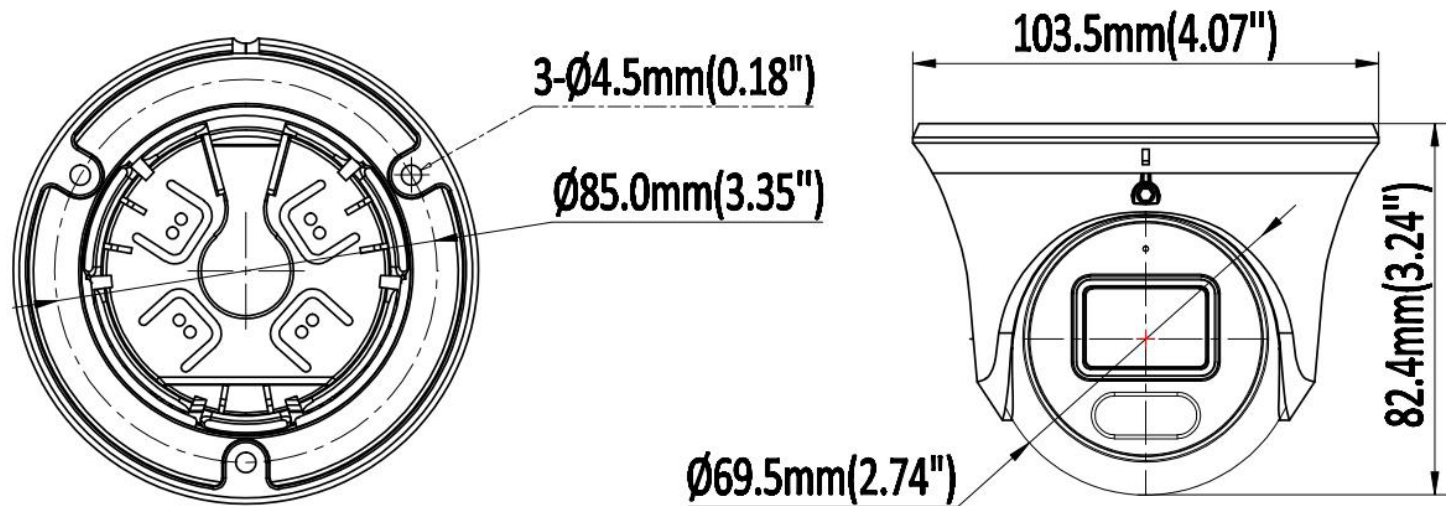

*Design and specifications are subjects to change without notice.

Technical Specifications

Camera: LGNXT05CVTF	
Image Sensor	1/2.7" CMOS Sensor
Signal System	PAL/NTSC
Effective Pixels	2592 (H) × 1944 (V)
Electronic Shutter	AUTO/ 1/50 (1/60) ~ 1/50,000sec
Minimum Illumination	0.01Lux at (F1.2, AGC ON) , 0 LUX with IR
Video Frame Rate	PAL/NTSC: 5MP at 20fps
Video Output	AHD / TVI / CVI / CVBS
Microphone	Only Supported in TVI mode
Camera Features	
S/N Ratio	≥ 50dB
Noise Reduction	2D DNR
Day/Night	Full Colour
White Balance	MWB / ATW / GRAY WORLD
Wide Dynamic Range	DWDR
IR LED	2 Warm Lights
Warm Light Range	20m / 65.62ft
Lens	
Focal Length	2.8 mm fixed lens
Field of View	2.8 mm : Horizontal FOV: 110°, Vertical FOV: 60°, Diagonal FOV: 126°
Lens Type	Fixed Iris
Mount Tyoe	M12
General	
Operating Conditions	-40°C ~ +60°C, RH 95% MAX
Power Supply	DC12V (±10%)
Power Consumption	Less than 8W
Protection Level	IP67
Material	Metal
Dimensions	Φ 103.5 x 82.4 mm (Φ 4.07" x 3.24")
Gross Weight	0.81 lb /370 g

*Design and specifications are subjects to change without notice.

What you may need



XLGNXLB10
Junction Box
Φ112.5 mm × 49.5mm



XLGNXPM03
Pole Mount
Φ170mm × 135.8mm × 43.7mm



XLGNXLB14C
Wall Mount
Φ120mm × 105.8mm x 183.5mm



XLGNXCM700
Pendent Mount Bracket
Φ116 mm × 734.5 mm

Accessories Mount

XLGNXLB10

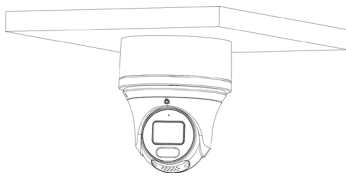

XLGNXLB14C

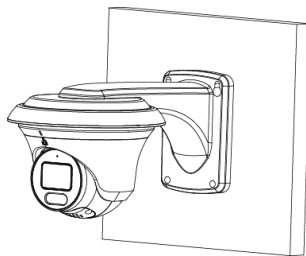

**XLGNXLB10 +
XLGNXLB14C**

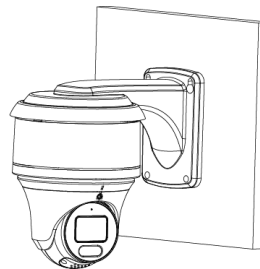

**XLGNXLB10 +
XLGNXCM700**

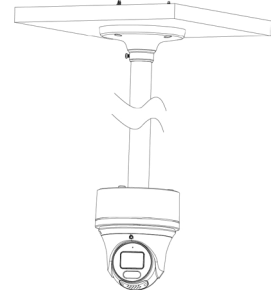

XLGNXPM03

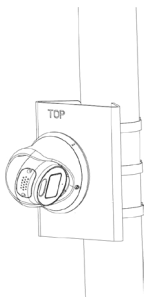

**XLGNXPM03 +
XLGNXLB10**

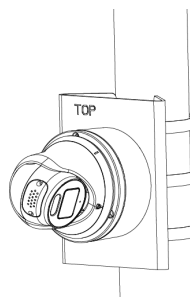

**XLGNXPM03 +
XLGNXLB14C**

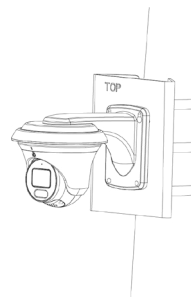

**XLGNXPM03 + XLGNXLB10 +
XLGNXLB14C**

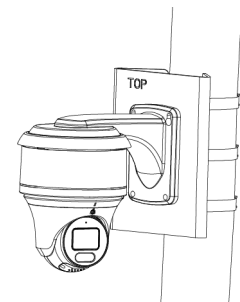

*Design and specifications are subjects to change without notice.